

HÉLICE 2 PALAS PERFORADAS PASANTES H2PP

Hélice
centrada

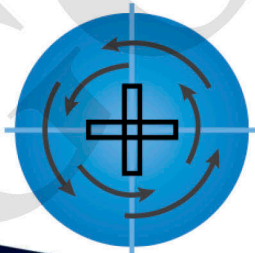

Hélice centrada
con deflectores

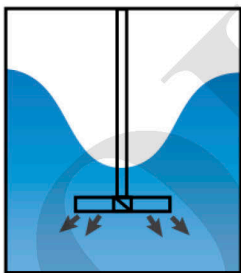
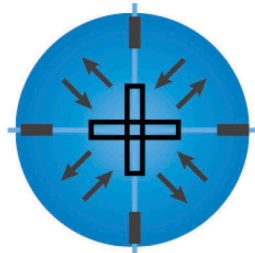
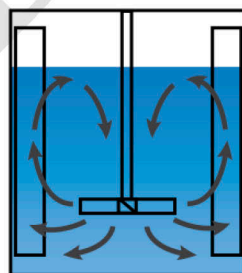

Hélice
descentrada

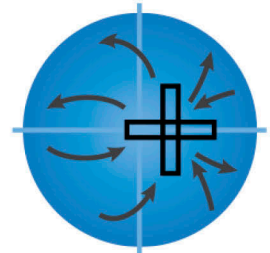
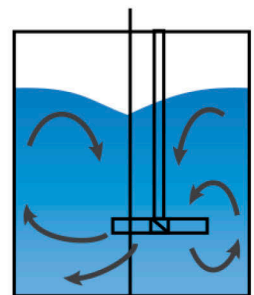

GOLDSPRAY S.L.

Pol. Ind. Masia del Juez
C/ Rajolers, 39
46.909 TORRENT - Valencia

Made in Spain 

 www.goldspray.com

 comercial@goldspray.com

 +34 96 156 58 36  672 645 248

 https://www.youtube.com/results?search_query=GOLDSPRAYSL

Hélice inox 2 palas perforadas

Stainless steel propeller 2 perforated blades

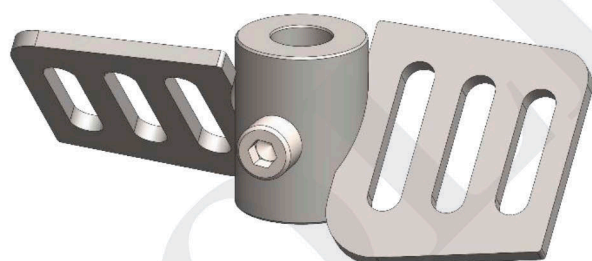
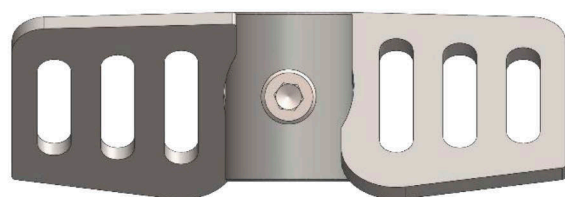
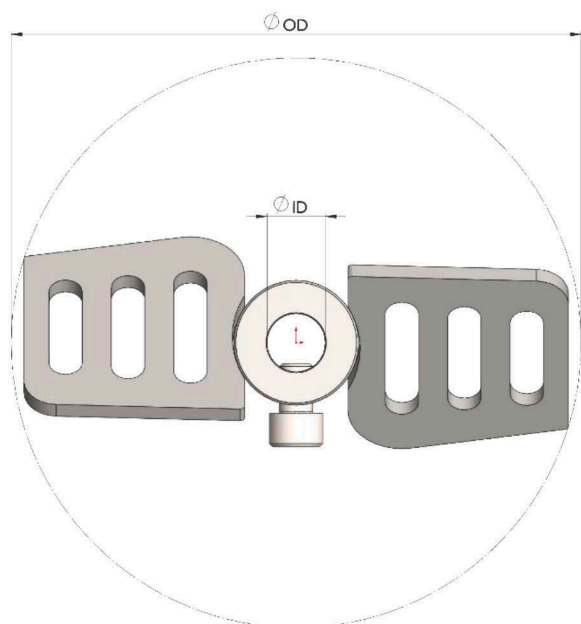

Material	Acero inoxidable 304/316
Material	Stainless Steel 304/316
Sentido de giro	A derechas según petición
Direction of rotation	Right hand according to request
Rosca	A medida (consulte precios)
Thread	Custom (ask prices)
Acabado	Pulido/Mate
Finish	Polished/Matt

ØOD mm	ØID (mm)	Grueso (mm)	Peso (Kg)	Número Palas	CÓDIGO
100	10-15	3		2	150.110.100
125	10-15	3		2	150.110.125
150	15-20	3		2	150.110.150
160	15-20	3		2	150.110.160
175	15-20	3		2	150.110.175
200	15-25	3		2	150.110.200
225	20-30	3		2	150.110.225
250	20-30	4		2	150.110.250
275	20-40	4		2	150.110.275
300	20-50	5		2	150.110.300
350	25-50	5		2	150.110.350
400	25-60	5		2	150.110.400

Sujeción mediante rosca a medida o tornillo de apriete transversal a lo largo del eje.

Disponible en acero inoxidable 304/316 consulte disponibilidad y precio.

Clamping by custom thread or transverse clamping screw along the axis.

Available in 304/316 stainless steel check availability and price.

GOLDSPRAY S.L.

Pol. Ind. Masia del Juez
C/ Rajolers, 39
46.909 TORRENT - Valencia

Made in Spain €

 www.goldspray.com

 comercial@goldspray.com

 +34 96 156 58 36  672 645 248

 https://www.youtube.com/results?search_query=GOLDSPRAYSL